

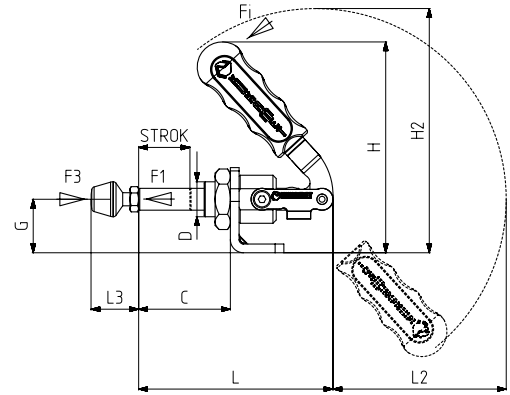

MODEL NO	PASLANMAZ (STAINLESS)	SİYAH (BLACK)	F1 (N)	F3 (N)	Fi	BASKI VİDASI (SQUEEZE SCREW)	STROK	AĞIRLIK (WEIGHT) (gr)
					VERİM YIELD (F1:Fi)			
511-0-M	S 511 -	B 511 -	550	700	20:1	M4X25	15	87
511-0	S 511 -	B 511 -	550	700	20:1	M4X25	15	92
511-1	S 511 -	B 511 -	800	970	24:1	M5X35	22	135
511-2	S 511 -	B 511 -	1500	1700	26:1	M6X40	27	280
511-3	S 511 -	B 511 -	2500	2640	27:1	M8X50	38	490
511-5	S 511 -	B 511 -	3500	3700	38:1	M10X70	53	960
511-6	S 511 -	B 511 -	4500	4650	38:1	M10X70	53	1070

F1 : BASKI KUVVETİ (EXERTING FORCE), F3 : TUTMA KAPASİTESİ (HOLDING CAPACITY), Fi : UYGULAMA KUVVETİ (APPLIED FORCE)

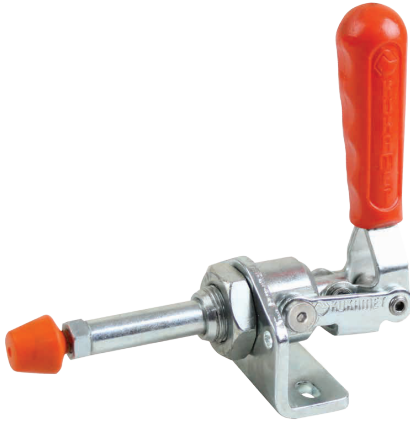

Ayak Tipi: Yatay Tabanlı
Body Mounting Base: Horizontal

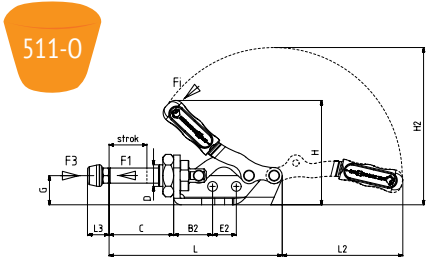
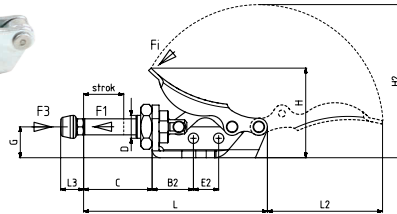
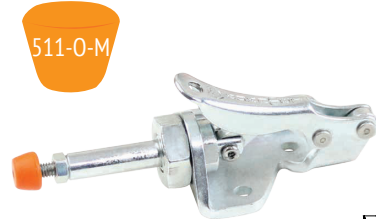
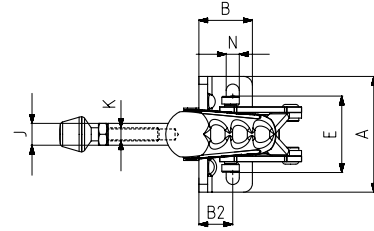

Ayak Tipi: Yatay Tabanlı
Body Mounting Base: Horizontal

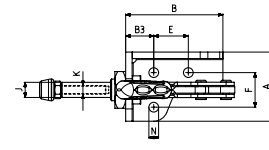
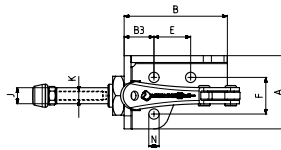

MODEL NO : 511-0-M
(KAPLAMASIZ METAL SAP)
(UNCOATED METAL HANDLE)

MODEL NO : 511-0

MODEL NO	A	B	B2	B3	C	D	E	E2	F	G	H	H2	J	K	L	L2	L3 Min	L3 Max	N
511-0-M	32	45	18	13	32	M10 x 1	16	11	16	13,5	39	67	7	M4	82	50,5	10	25	Ø 4,5
511-0	32	45	18	13	32	M10 x 1	16	11	16	13,5	48	73	7	M4	82	56	10	25	Ø 4,5
511-1	44	20	11,5		34	M12 x 1,5	21,5 - 31,5			19,5	79,5	92	8	M5	73	68,5	15	38	5,5 x 10,5
511-2	53	24,5	15,5		42	M16 x 1,5	30 - 40			24,5	96	111	10	M6	89	80	19	46	6 x 11
511-3	60	30	17,5		56	M20 x 1,5	33,5 - 42,5			30,5	137	140	12	M 8	116	80	24	58	6,5 x 11
511-5	78	36	21		75	M24 x 1,5	42 - 57			38	152	179	14	M10	155	135	32	74	8,5 x 16
511-6	78	36	21		75	M24 x 1,5	42 - 57			38	152	179	16	M10	155	135	32	74	8,5 x 16